

COATS®

Wheel Balancer Models

1400 2D, 1500 3D, 1600 3D



Model 1400 Shown



Model 1500 Shown



Model 1600 Shown

See
★ **Balancing Your
First Tire**
on page 7.

Safety Instructions **Set Up Instructions** **Operation Instructions** **Maintenance Instructions**

READ these instructions before placing unit in service. KEEP these and other materials delivered with the unit in a binder near the machine for ease of reference by supervisors and operators.

HENNESSY
INDUSTRIES

1601 J. P. Hennessy Drive, LaVergne, TN USA 37086 615/641-7533 800/688/6359 www.coatsgarage.com
HENNESSY INDUSTRIES INC. Manufacturer of AMMCO®, COATS® and BADA® Automotive Service Equipment and Tools.

Manual Part No.: 85610675 00a
Revision: 09/16



NOTICE

Read entire manual before assembling, installing, operating, or servicing this equipment.

Table of Contents

Important Safety Instructions	1	Mounting Wheel On Balancer Shaft	22
Owner's Responsibility	1	Standard Back Cone/Collet Mounting	22
Operator Protective Equipment	1	Optional Front Cone/Collet Mounting	23
Definitions of Hazard Levels	1	Alternate Mounting	23
Safety Notices and Decals	2	Direct Select™	
Standard Safety Devices	3	Weight Placement Location	24
Label Locations	4	Weight Placement Options	24
Specifications	5	Direct Select™ Control Panel Models	24
Features	5	Direct Select™ Touchscreen Models	24
Standard Accessories	5	Setting Wheel Dimensions (DIM)	25
Set Up Instructions	6	Definition of Dimensions (DIM)	25
Receiving	6	Basic Wheel Data Entry	25
Electrical Requirements	6	Entering Wheel Dimensions Manually	26
Machine Set Up	6	Balancing A Wheel	
Floor and Space Requirements	6	Using Direct Select™	26
Connect to Power	6	Dynamic Balancing	26
Balancing Your First Tire	7	Static Balancing	27
Principle Operating Parts	8	Corrective Weight Placement	28
Know Your Unit	8	Behind Spoke Mode	28
Control Panel Model Layout	10	ProBalance Technology™	
Control Panel Function and Review	10	On Touchscreen Models	29
Touchscreen Model Layout	12	Match Balance (Optimization)	
Touchscreen Function and Review	12	- If Equipped	30
Power Switch	15	Match Balance Mode	30
Weight Tray	15	Calibration	31
Using The Offset Arm	15	Machine Calibration	31
Using The Laser Locator	17	Maintenance Instructions	32
Using The Line Laser	17	After Balance Vibration Problems	33
Laser Guided Operation™ System	18	Troubleshooting	33
Using the Hood Sonar		Notes	35
(Width Sensor - if equipped)	20		
Hood (Wheel Guard)	20		
Auto Wheel Positioning (if equipped)	20		
12 o'clock Laser	20		
Display Mount	21		
Control Panel (if equipped)	21		
Touchscreen (if equipped)	21		

IMPORTANT SAFETY INSTRUCTIONS

READ ALL INSTRUCTIONS

1. Eye and face protection requirements:
“Protective eye and face equipment is required to be used where there is a reasonable probability of injury that can be prevented by the use of such equipment.” O.S.H.A. 1910.133(a) Protective goggles, safety glasses, or a face shield must be provided by the owner and worn by the operator of the equipment. Care should be taken to see that all eye and face safety precautions are followed by the operator. ALWAYS WEAR SAFETY GLASSES. Everyday glasses only have impact resistant lenses, they are not safety glasses.
2. Do not disable hood safety interlock system, or in any way shortcut safety controls and operations.
3. Be sure that wheels are mounted properly, the hub nut engages the arbor for not less than four (4) turns, and the hub nut is firmly tightened before spinning the wheel.
4. Read and understand this manual before operating. Abuse and misuse will shorten the functional life.
5. Be sure the balancer is properly connected to the power supply and electrically grounded.
6. Do not operate equipment with a damaged cord or if the equipment has been dropped or damaged – until it has been examined and repaired by a qualified serviceman.
7. Do not let cord hang over edge of table, bench, or counter or come in contact with hot manifolds or moving fan blades.
8. If an extension cord is necessary, a cord with a current rating equal to or more than that of the equipment should be used. Cords rated for less current than the equipment may overheat. Care should be taken to arrange the cord so that it will not be tripped over or pulled.
9. Keep guards and safety features in place and in working order.
10. Wear proper clothing. Safety toe, non-slip footwear and protective hair covering to contain hair is recommended. Do not wear jewelry, loose clothing, neckties, or gloves when operating the balancer.
11. Keep work area clean and well lighted. Cluttered and/or dark areas invite accidents.
12. Avoid dangerous environments. Do not use power tools or electrical equipment in damp or wet locations, or expose them to rain.
13. Avoid unintentional starting. Be sure the balancer is turned OFF and power disconnected before servicing.
14. Disconnect the balancer before servicing.
15. Use only manufacturer’s recommended accessories. Improper accessories may result in personal injury or property damage.
16. Repair or replace any part that is damaged or worn and that may cause unsafe balancer operation. Do not operate damaged equipment until it has been examined and serviced by an authorized service technician only. This unit contain no user serviceable parts.
17. Never overload or stand on the weight tray or any part of the balancer.
18. Do not allow untrained persons to operate machinery.
19. To reduce the risk of fire, do not operate equipment in the vicinity of open containers or flammable liquids (gasoline).
20. Adequate ventilation should be provided when working on or operating internal combustion engines.
21. Keep hair, loose clothing, fingers, and all parts of body away from moving parts.
22. Use equipment only as described in this manual. Do not modify the unit or remove protective covers or housings.
23. Use only manufacturer’s recommended attachments and accessories.
24. The laser unit is not to be opened [except for battery change (where applicable) or modified by the customer, nor is it allowed to attempt to cheat or defeat safety interlocks (where applicable)]. Never operate the laser if defective or cover/seal is defective.
25. Do not point laser or allow laser light to be directed or reflected toward other people or reflective objects. Potential eye or skin exposure to laser radiation exists if these instruction are not followed.

SAVE THESE INSTRUCTIONS

Important Safety Instructions

Owner's Responsibility

To maintain machine and user safety, the responsibility of the owner is to read and follow these instructions:

- Follow all installation instructions.
- Make sure installation conforms to all applicable Local, State, and Federal Codes, Rules, and Regulations; such as State and Federal OSHA Regulations and Electrical Codes.
- Carefully check the unit for correct initial function.
- Read and follow the safety instructions. Keep them readily available for machine operators.
- Make certain all operators are properly trained, know how to safely and correctly operate the unit, and are properly supervised.
- Allow unit operation only with all parts in place and operating safely.
- Carefully inspect the unit on a regular basis and perform all maintenance as required.
- Service and maintain the unit only with authorized or approved replacement parts.
- Keep all instructions permanently with the unit and all decals/labels/notices on the unit clean and visible.
- Do not override safety features.

Operator Protective Equipment

Personal protective equipment helps make tire servicing safer. However, equipment does not take the place of safe operating practices. Always wear durable work clothing during tire service activity. Loose fitting clothing should be avoided. Tight fitting leather gloves are recommended to protect operator's hands when handling worn tires and wheels. Sturdy leather work shoes with steel toes and oil resistant soles should be used by tire service personnel to help prevent injury in typical shop activities. Eye protection is essential during tire service activity. Safety glasses with side shields, goggles, or face shields are acceptable. Back belts provide support during lifting activities and are also helpful in providing operator protection. Consideration should also be given to the use of hearing protection if tire service activity is performed in an enclosed area, or if noise levels are high.

Definitions of Hazard Levels

Identify the hazard levels used in this manual with the following definitions and signal words:

DANGER

Watch for this symbol:



It Means: Immediate hazards, which will result in severe personal injury or death.

WARNING

Watch for this symbol:



It Means: Hazards or unsafe practices, which could result in severe personal injury or death.

CAUTION

Watch for this symbol:



It Means: Hazards or unsafe practices, which may result in minor personal injury or product or property damage.



Watch for this symbol! It means BE ALERT! Your safety, or the safety of others, is involved!

Safety Notices and Decals



Failure to follow danger, warning, and caution instructions may lead to serious personal injury or death to operator or bystander or damage to property. Do not operate this machine until you read and understand all the dangers, warnings and cautions in this manual. For additional copies of either, or further information, contact:

Hennessy Industries, Inc.

1601 JP Hennessy Drive
 LaVergne, TN 37086
 (615) 641-7533 or (800) 688-6359
 www.hennessyind.com



The motor unit of this machine contains a Class 2 laser with a maximum output less than 1mW at a wave length of 635-660 nm.



Use of controls, adjustments or performance of procedures other than those specified herein may result in hazardous radiation exposure.

In case of failure, the entire motor unit must be replaced.

Explanatory Label



Certification Label

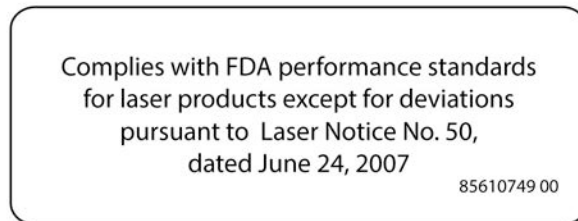

Electric Shock Label

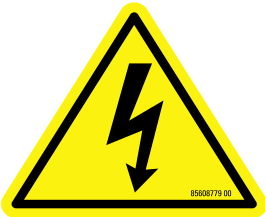

Laser Hazard Label



MET Lab Compliance Label

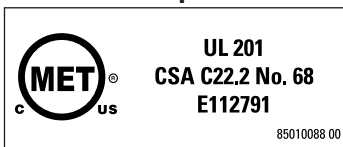

* Does not apply to Australian models.

Sample Manufacturing I.D. Label

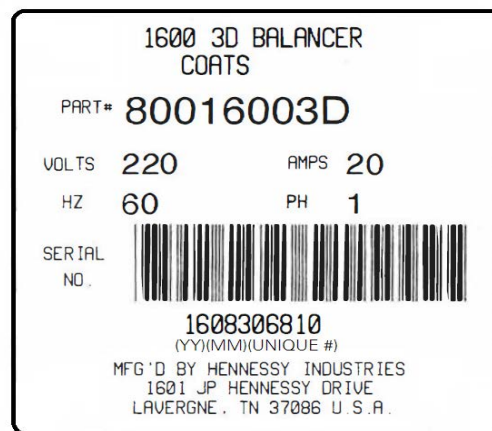

⚠ WARNING	⚠ AVERTISSEMENT
RISK OF EXPLOSION This equipment has internal arcing or sparking parts which should not be exposed to flammable vapors. Do not locate in a recessed area or below floor level. THIS EQUIPMENT MUST BE EARTH-GROUNDED The earth-ground connector built into the power cord provides protection to reduce the risk of electrical shock.	RISQUE D'EXPLOSION Cet équipement possède des pièces internes, pouvant lancer des arcs ou jeter des étincelles, et qui ne devraient pas être exposées à des vapeurs inflammables. Ne situez pas l'équipement dans des endroits encastrés ou en-dessous du niveau du plancher. CET ÉQUIPEMENT DOIT ÊTRE MIS À LA TERRE Le raccord de mise à la terre incorporé dans le cordon de puissance fournit une protection afin de réduire le risque d'électrocution.
⚠ CAUTION	⚠ ATTENTION
Do not use below garage floor or grade level. Disconnect power before servicing this equipment. To prevent electrical shock, do not remove cover. No user serviceable parts inside. Refer servicing to qualified service personnel.	N'utilisez pas en-dessous du plancher du garage ou du palier. Débranchez le cordon de puissance avant de faire l'entretien de cet équipement. Afin de vous protéger contre l'électrocution, n'enlevez pas le couvercle. Aucune pièce interne ne nécessite d'entretien par l'utilisateur. Référez l'entretien à un personnel de service qualifié.

8113927 05

Standard Safety Devices

- STOP key for stopping the wheel under emergency conditions.
- A hood guard of high impact plastic that is designed to prevent the counterweights from flying out in any direction except towards the floor.
- A hood switch interlock system that prevents the machine from starting if the guard is not lowered and stops the wheel whenever the guard is raised.

⚠ WARNING

Risk of Injury
 This machine is provided with a wheel guard interlock. Do not defeat it's purpose.

8111840 02

⚠ AVERTISSEMENT

Danger de Blessures
 Cet appareil est livré avec un verrouillage du garde de la roue. Ne nuisez pas à son fonctionnement.

8111840FR 02

⚠ WARNING

Maximum Size of Wheel Rating

Weight	Diameter	Width
90 lbs./40 kg	42 in./107 cm	19 in./48cm

Maximum Duty Cycle

30 Wheels/Hour @ 90 lbs./40 kg

85610497 00

Australian Models Only

⚠ WARNING	⚠ AVERTISSEMENT												
Maximum Size of Wheel Rating <table style="width: 100%; text-align: center;"> <tr> <td>Weight</td> <td>Diameter</td> <td>Width</td> </tr> <tr> <td>160 lbs.</td> <td>44 in.</td> <td>20 in.</td> </tr> </table> Maximum Duty Cycle 30 Wheels/Hour @ 160 lbs.	Weight	Diameter	Width	160 lbs.	44 in.	20 in.	Capacité de la Dimension Maximale de la Roue <table style="width: 100%; text-align: center;"> <tr> <td>Poids</td> <td>Diamètre</td> <td>Largeur</td> </tr> <tr> <td>73Kg</td> <td>111,8cm</td> <td>50,8cm</td> </tr> </table> Cycle de Service Maximum 30 Roues/Heure @ 73Kg	Poids	Diamètre	Largeur	73Kg	111,8cm	50,8cm
Weight	Diameter	Width											
160 lbs.	44 in.	20 in.											
Poids	Diamètre	Largeur											
73Kg	111,8cm	50,8cm											

85610679 00

Label Locations

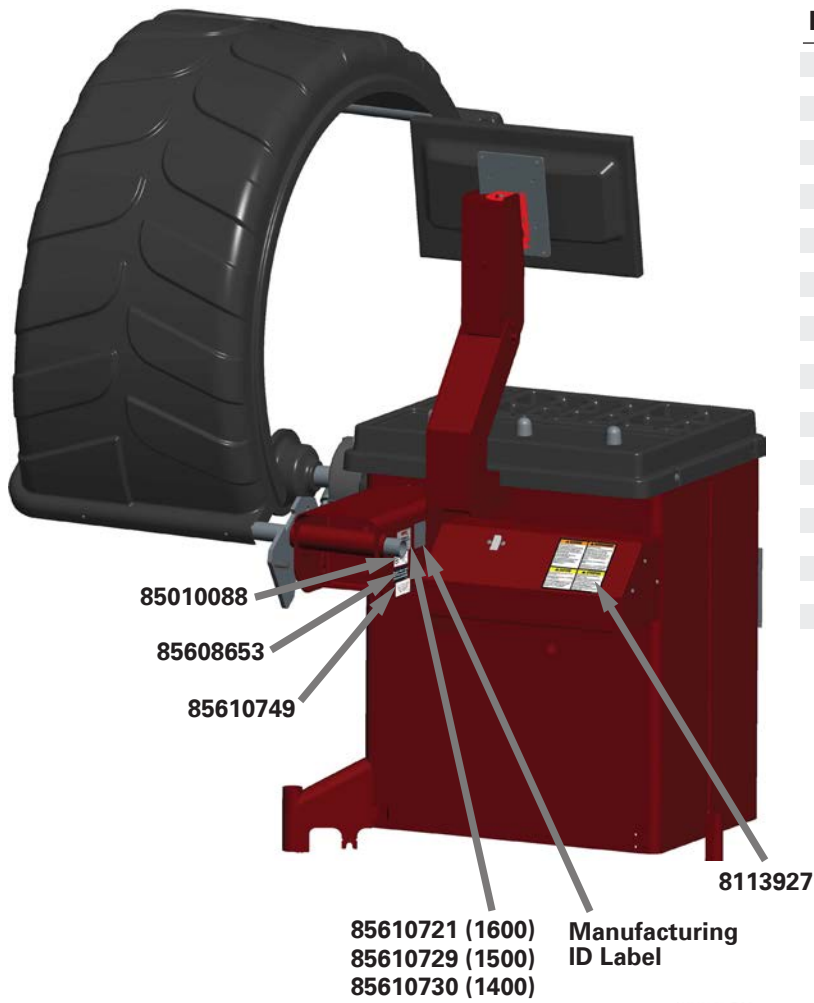

Part Number	Description
8113927	Caution / Warning
8120446	Motor Rotation
85010088	MET Lab Compliance
85608653	Patent Notice
85608779	Electric Shock
85610662	Main, 1400/1500/1600
85610679	Warning
85610721	Nameplate-1600
85610729	Nameplate-1500
85610730	Nameplate-1400
85610746	Laser Hazard
85610747	Explanatory
85610749	Certification

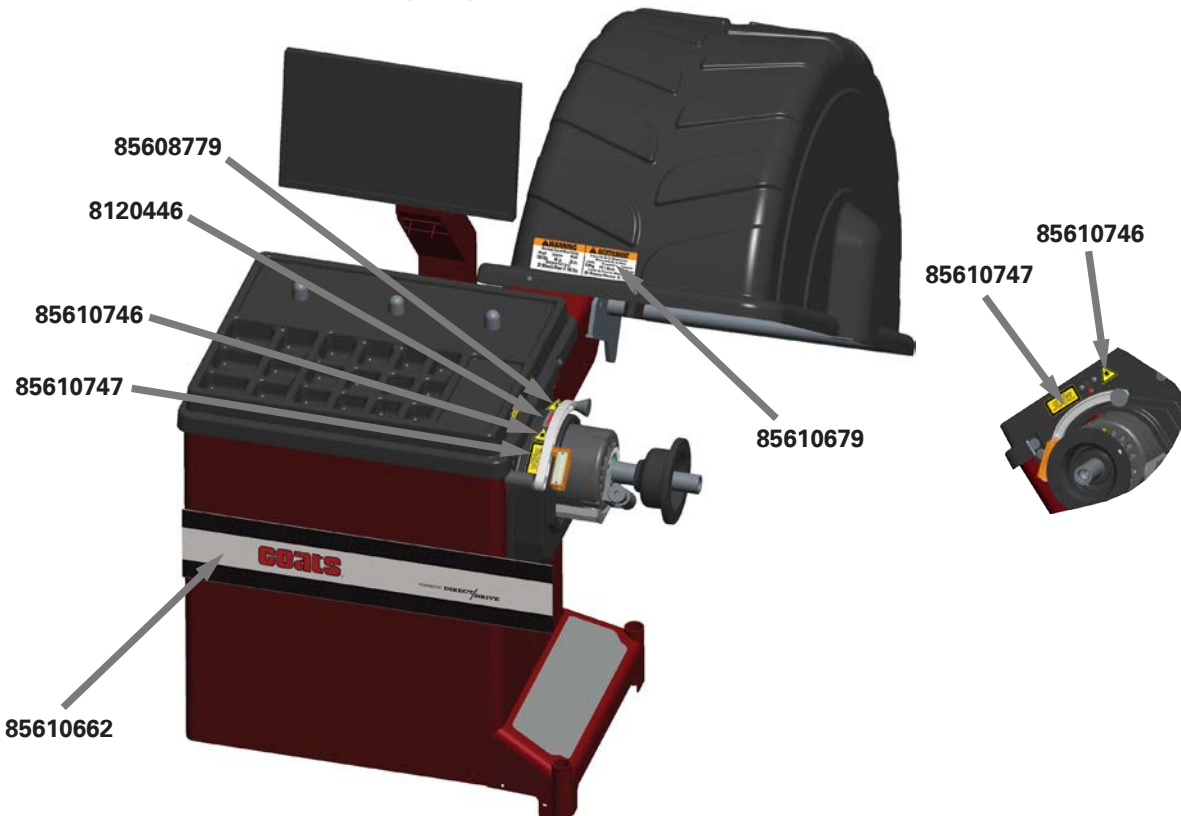

Specifications

Wheel Diameter Range

8 - 30 inches (203 - 762 mm)

Wheel Width Range

2 - 20 inches (51 - 508 mm)

Maximum Outside Tire Diameter

Up to 44 inches (1118 mm)

Maximum Tire/Wheel Weight

160 pounds (73 Kg)

90 pounds (40 Kg) - Australia Only

Mounting Shaft Diameter

40 mm

Resolution (Round Off Mode)

0.25 ounce (7 grams), position 1.40 degrees

Resolution (Fine Mode)

0.01 ounce (.3 grams), position 1.40 degrees

Balancing Display Increments

0.25 or 0.01 ounces (7 or .3 grams)

Electrical Requirements

230V, 60 Hz, 20A, 1 ph.

NEMA L6-20R

230V, 60 Hz, 20A, 3 ph.

NEMA L15-20R

(use grounding type plug)

240V, 50 Hz, 10A, 1 ph.

(Australia Only)

Footprint

Width: 57 inches (1448 mm)

Depth: 55 inches (1397 mm)

Height: 75 inches (1905 mm)

Shipping Weight

650 pounds (295 Kg)

(without accessories)

Features

- Direct Drive System
- Simple, Interactive User Interface - Touchscreen
- Operator Memory for Two Different Users
- Direct Select™ Weight Placement
- Static, Dynamic And Multiple Tape-A-Weight
- Automatic Data Entry for Offset, Diameter & Width - Manual Entry Backup on all Parameters
- Automatic Start When Hood Is Lowered
- Hood Safety Interlock System
- Auto Wheel Positioning
- Behind the Spoke Weight Placement
- ProBalance Technology™ (certain models)
- Laser Guided Operation™ System
- 12 O'clock Laser (certain models)
- MET Lab Listing (Exc. Australia)

Standard Accessories

<i>Part Number</i>	<i>Description</i>
8500920401	Mounting Shaft
85608850	Weight Tray Stud (3 included)
85609499	8 Double Sided Collets
8309011	Calipers
5113175	Premium Wheel Weight Hammer
85607503	Premium Quick Nut
8112106	Small Pressure Cup & Rubber Lip
85608312	No Mar Ring
8112107	Spring
8113390	Scraper
85610715	Shadow Board

Set Up Instructions

Receiving

The shipment should be thoroughly inspected as soon as it is received. The signed bill of lading is acknowledgement, for the carrier, of receipt in good condition of the shipment covered by our invoice.

If any of the goods called for on this bill of lading are shorted or damaged, do not accept them until the carrier makes a notation of the shorted or damaged goods on the freight bill. Do this for your own protection.

NOTIFY THE CARRIER AT ONCE if any hidden loss or damage is discovered after receipt and request him to make an inspection. If the carrier will not do so, prepare an affidavit to the effect that you have so notified the carrier (on a certain date) and that he has failed to comply with your request.

IT IS DIFFICULT TO COLLECT FOR LOSS OR DAMAGE AFTER YOU HAVE GIVEN THE CARRIER A CLEAR RECEIPT.

File your claim with the carrier promptly. Support your claim with copies of the bill of lading, freight bill, invoice, and photographs, if possible.

Although COATS® responsibility ceases upon delivery of the shipment to the carrier, we will gladly assist in tracing lost shipments. Our willingness to assist in every possible manner does not make COATS responsible for collection of claims, or replacement of lost or damaged materials.

Electrical Requirements

See serial tag for the appropriate power requirements of your machine.

Always have a qualified electrician install the proper receptacles in accordance with state and local codes.

Machine Set Up



Do not use the display, faceplate, hood or mounting shaft to lift the balancer. Use help to remove the balancer from the pallet. The unit is heavy and the weight is not evenly distributed. Dropping the unit may cause personal injury or equipment damage.



Do not attempt to install and set up the unit yourself. Contact COATS as noted below.

A factory trained COATS Service Technician must perform the install, set up, and initial test procedures on your wheel balancer. Do not attempt to install and set up the unit yourself. Accurate and reliable operation of your unit depends on proper installation. Please contact COATS directly at 1-800-688-9240 for the Certified Service Partner nearest you.

Floor and Space Requirements

The balancer must be located on a flat floor of solid construction, preferably concrete. The balancer must sit solidly on its three feet. If the balancer is not level, does not sit solidly on its three feet, or is placed on an unstable floor, the balancer will not function properly and may produce inaccurate balance readings.

Do not operate the balancer while it is on the pallet.

Select a location for the balancer that provides a level, solid floor, and adequate clearance around and above the balancer. Make sure the location selected has enough room above and behind the unit so the hood can be raised completely. The location must also provide working room for mounting and removing wheels. Make sure the area has adequate lighting.

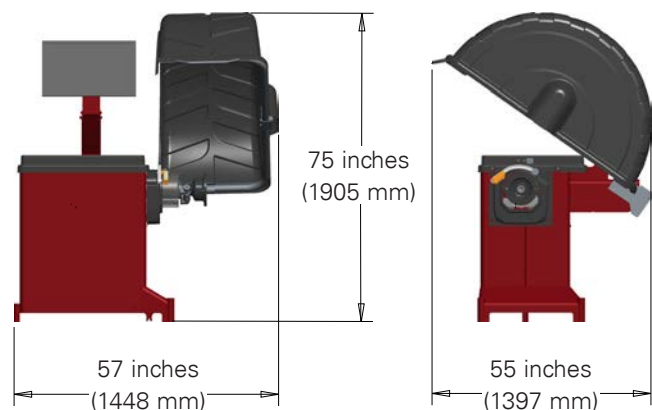

Figure 1 - Space Requirements

Connect to Power

Your factory trained COATS® Service Technician should do the final check to verify the power installation before connecting the balancer to a power supply. Failure due to improper power connection may void the warranty.

Balancing Your First Tire

- 1. Turn the machine OFF then ON (resets machine).**

Note: The machine wakes up using standard clip-on wheel weight locations (Clip 1 & Clip 2) and wheel dimensions.

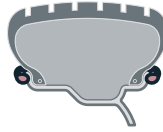

- 2. Mount a tire/wheel on the balancer that will use standard clip-on wheel weights.**

Use the most appropriate mounting method.

- 3. Always remove any weights already attached to the wheel.**

- 4. Enter A & D wheel dimensions using offset arm.**

For Automatic Measurement — pull offset arm out to the wheel, hold it still at clip-on weight position against wheel flange, and wait for BEEP. Return arm to home position.

Clip-on Weight Location — viewed on a cut-away rim for clarification.



Figure 2 - Clip-On Weight Location

- 5. Enter Width wheel dimension.**

For Automatic Measurement — Lower hood.

For Manual Entry — Use plastic calipers to measure wheel width. Press W icon. Use keypad to enter Width value (between 2.0 and 20.0 inches).

- 6. Lower hood; wheel spins and unbalances are measured and displayed.**

The corrective weight amount appears in the weight display window for inboard and outboard weight locations.

- 7. Raise hood after tire stops rotating.**

Note: Wait for wheel to stop before raising the hood.

- 8. Position wheel at inboard corrective weight position.**

The inboard center bar highlights.

For Automatic Wheel Positioning — Wheel stops at corrective weight position.

For Manual Wheel Positioning — Rotate wheel until the inboard center bar highlights.

- 9. Attach inboard corrective weight.**

Attach specified weight amount at top-dead-center on inside flange of wheel (clip 1).

- 10. Position wheel at outboard corrective weight position.**

The outboard center bar highlights.

- 11. Attach outboard corrective weight.**

Attach specified weight amount at top-dead-center on outside flange of wheel (clip 2).

- 12. Lower the hood to respin the tire/wheel and check balance.**

The inboard and outboard weight readings should now be 0.00.

Note: Throughout this manual tire dimensions are referred to as A, W, and D, see figure 3.

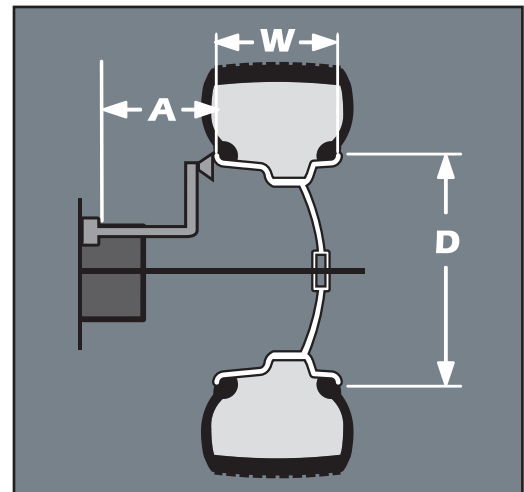

Figure 3 - A, W and D Tire Dimensions

Principle Operating Parts

Know Your Unit

Compare this illustration with the unit before placing it into service. Maximum performance and safety will be obtained only when all persons using the unit are fully trained in its parts and operation. Each user should learn the function and location, of all controls.

Prevent accidents and injuries by ensuring the unit is properly installed, operated and maintained.

- A** - Control Panel or Touchscreen (Monitors)
- B** - ON/OFF Switch (Back Of Machine)
- C** - Plug (Back Of Machine)
- D** - Weight Tray Studs
- E** - Weight Tray
- F** - 12 o'clock Laser (if equipped)
- G** - Offset Arm, Measures A & D of Tire/Wheel (Shown In Home Position)
- H** - Hood (Wheel Guard)
- I** - Hood Sonar (Width Sensor - if equipped)
- J** - Faceplate
- K** - 40 mm Shaft
- L** - Laser Locator
- M** - Line Laser
- N** - Cone/Collet

Note: Throughout this manual, wheel weights are referred to as Clip-on or Tape-A-Weight. Figure 4 shows an example of each weight.

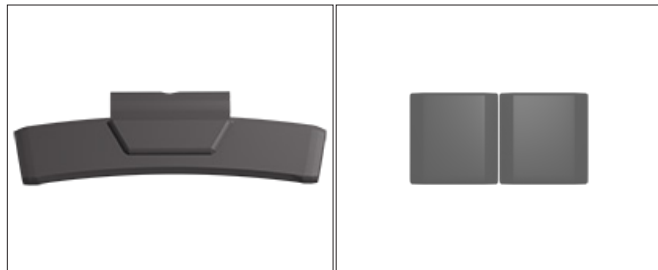

Clip-on Weight

Tape-A-Weight

Figure 4 - Corrective Weight Examples. For Best Results, use BADA® Brand Wheel Weights.



Control Panel Model Layout

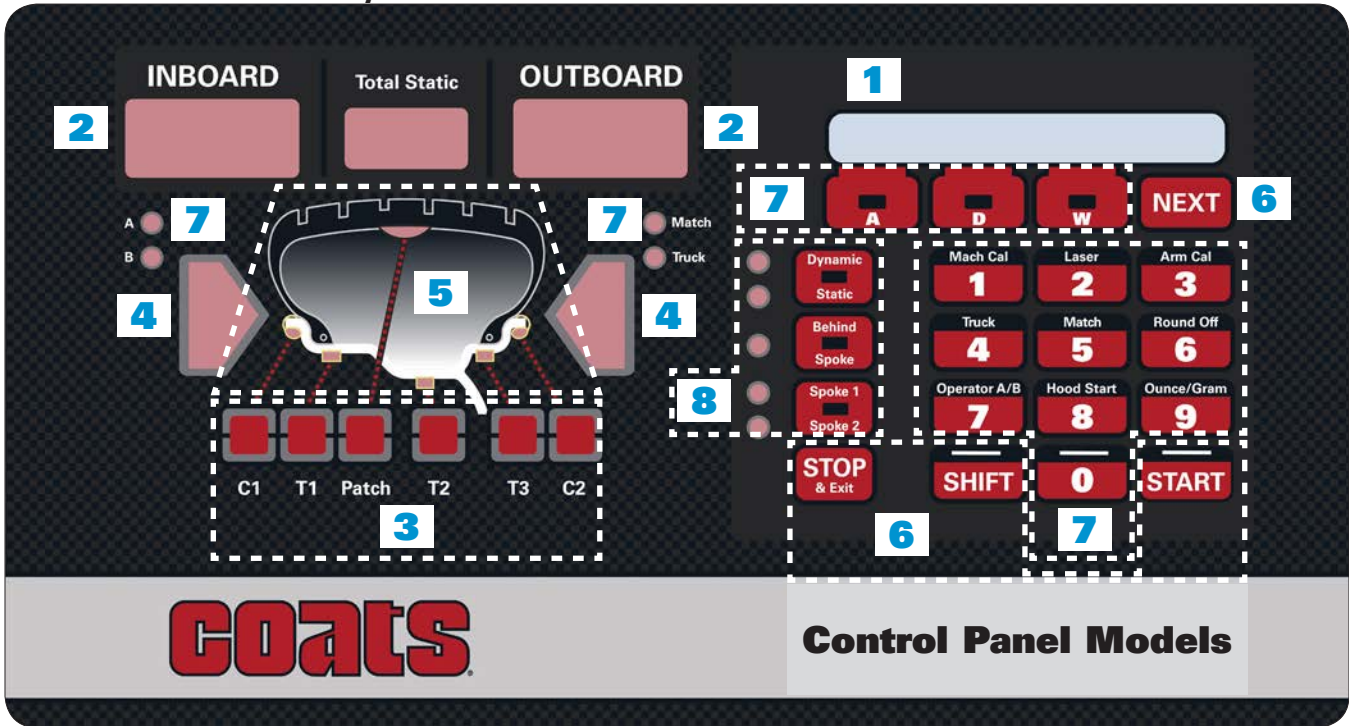

Figure 5 - Control Panel Model Feature Reference

Control Panel Function and Review

1 Information Box



Displays A, D, and W values, instructions, functions and error messages for the operator.

2 Weight Display Windows

Two weight display windows, one inboard and one outboard, are positioned above the wheel cross section diagram. After a wheel measurement cycle, the balancer calculates the corrective weight amount and indicates it in the appropriate display window. All weight readings are shown in ounces or grams.

The "Total Static" window indicates the value of the total static unbalance. See MATCH BALANCE (Optimization) on page 28 for further details.

3 Direct Select™ Weight Location Keys & Cross-section Diagram (See page 22)

	Clip 1 or T1 Tape	When selected, the inboard weight location on the wheel cross-section diagram illuminates.
	T2 Tape (laser dot blinks), T3 Tape, or Clip 2	When selected, the outboard weight location on the wheel cross-section diagram illuminates.
	Patch Static	When selected, the static weight location on the wheel cross-section diagram illuminates.





4 Weight Position Bars

Located on either side of the wheel cross-section diagram are the weight position bars, one inboard and one outboard. After a measurement cycle, rotate wheel until the center weight position bar blinks, indicating the correct weight placement position is at top-dead-center. When in laser mode (T2 Tape Laser Locator), special blinking bars appear on either side of the center bar to indicate the correct outboard weight placement position. Also remember that the laser beam dot will stop blinking when it is at the correct weight placement location. (become lit steady)





5 Wheel Cross-section Graphic and Indicators

The wheel cross-section graphic will illuminate the current weight placement selections.



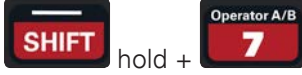

6 Navigation Keys

	SHIFT	Press/hold SHIFT key and press a numbered key to access options, modes and functions.
	STOP & EXIT	Press to deactivate a function, error or to release the wheel so that it can be manually positioned.
	START	Lower hood and press this key to begin a wheel measurement cycle.
	NEXT	Press key to access additional functions or instructions, such as moving to the next weight location.

7 Balance Option Keys (and Mode Indicators)

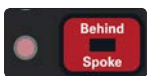
	Wheel Dimensions (DIM)	Press either A, D or W plus numbered key to manually enter wheel data. For additional information, see setting Wheel Dimensions (DIM) on page 23.
	Passenger Car or Truck	Toggle to select either 0.25-ounce passenger car (default) or 0.50-ounce Truck (RV-Lt Truck, heavy wheels). Mode indicator illuminates when activated.
	Round Off or Fine	Toggle to select either a 0.25-ounce (default) or 0.01-ounce (fine) weight increment option.
	Operator A or Operator B	Toggle between two operator memories, A (default) or B. Mode indicator illuminates the active memory.
	Hood Start	Toggle ON (default) or OFF. Sets balancer to automatically start spin cycle when hood is lowered and hood safety interlock system is engaged.
	Ounce or Gram	Toggle to select either Ounce (default) or Gram.

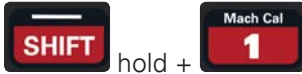
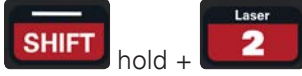
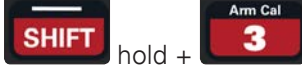
8 Balance Mode Keys (and Mode Indicators)

	Dynamic, Dynamic/Total Static or Static	Press to cycle through balance modes. For additional information, see Balance Wheel, page 24-25.
	Behind Spoke	Toggle ON or OFF. See Behind Spoke on page 26 for further details. Mode indicator illuminates when activated.
	Spoke 1 or Spoke 2	Use to set Spoke 1 and Spoke 2 locations for adhesive weights (hidden weights). See Behind Spoke on page 26 for further details.
	Machine Calibration	See Machine Calibration on page 29 for further details. Mode indicator illuminates when activated.
	Laser	Toggle ON or OFF to manually activate Laser Guided Operation™ mode.
	Arm Calibration	Machine Calibration is required before Arm Calibration. The Arm Calibration mode is activated.
	Match Balance	See Match (Optimization) on page 28 for further details. Mode indicator illuminates when activated.

Touchscreen Model Layout

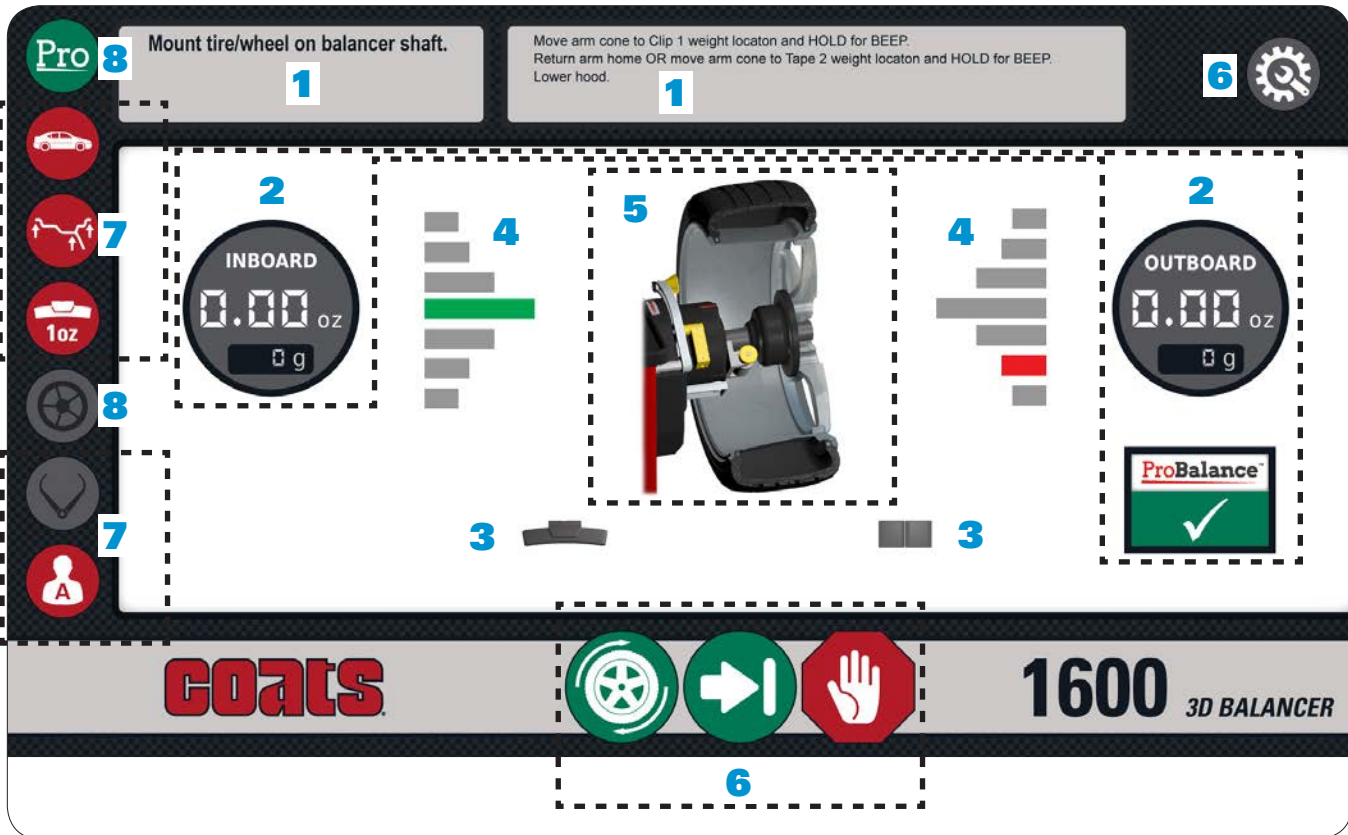

Figure 6 - Default Touchscreen Model Feature Reference

Touchscreen Function and Review

1 Information / Instruction Windows

Displays instructions, functions and error messages for the operator.

2 Weight Display Windows

Two weight display windows, one inboard and one outboard, are positioned by the weight position bars. After a wheel measurement cycle, the balancer calculates the corrective weight amount and indicates it in the appropriate display window. All weight readings are shown in ounces or grams.

The ProBalance Technology™ window indicates the value of any excessive residual unbalance. See ProBalance Technology™ - On Touchscreen Models on page 27 for further details.

3 Direct Select™ Weight Location Icons & Cross-section Diagram

	Direct Select™ Weight Location	Select to go to the Direct Select Weight Location Screen, see page 22.
	Clip 1 or T1 Tape	The activated inboard weight location on the wheel cross-section diagram.
	T2 Tape, T3 Tape, or Clip 2	The activated outboard weight location on the wheel cross-section diagram.





4 Weight Position Bars

Located on either side of the wheel cross-section diagram are the weight position bars, one inboard and one outboard. After a measurement cycle, the wheel stops and the center weight position bar blinks, indicating the correct weight placement position is at top-dead-center. When in laser mode (T2 Tape laser locator), special blinking bars appear on either side of the center bar to indicate the correct outboard weight placement position. Also remember that the laser beam dot will stop blinking when it is at the correct weight placement location (becomes lit steady).





5 Wheel Cross-section Graphic and Indicators

On the main screen, a wheel cross-section graphic illustrates the wheel balancer operational status.



6 Navigation Icons







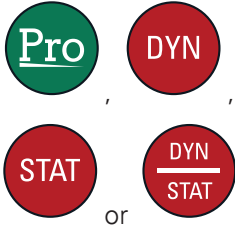



	Settings	Select this icon to access and set additional balancer functions.
	STOP & EXIT	Deactivates a function or error. Also use to release the wheel so that it can be manually positioned.
	SPIN	Lower hood and press this icon to begin a wheel measurement cycle.
	NEXT	Press this icon to access additional functions or instructions, such as moving to the next weight location.

7 Balance Option Icons

	Operator A or Operator B	The Operator Memory option that is activate. Toggle between two operator memories A (default) or B.
	Passenger Car or Truck	The weight increment option that is activated. Toggle to select either 0.25-ounce passenger car (default) or 0.50-ounce Truck (Lt Truck, heavy wheels).
	Round Off or Fine	Toggle to select either a 0.25-ounce (default) or 0.01-ounce (fine) weight increment option.
	DIM ON or DIM OFF	Toggle wheel dimensions ON or OFF (default). See Setting Wheel Dimensions (DIM) on page 23.

8 Balance Mode Icons

	ProBalance, Dynamic, Static or Dynamic/Static	The Balance mode that is activated. Scroll to select Dynamic (default), ProBalance, Static or Dynamic/Static. When enabled, the ProBalance Technology™ icon button indicates any excessive residual unbalance.
	Behind Spoke	Select Behind Spoke mode to activate (turns red). See Behind Spoke on page 26 for further details.

 Settings Screen Icons		
  or	Documentation Menu	Access these screen for a listing of our documentation and video website addresses.
  or	User Menu	Access these screen to get the following operator information: <ul style="list-style-type: none"> • Current weight and balance mode • Relative wheel dimensions and imbalance data • Select the individual Operator button (A memory or B memory) to show the relative information.
  or	Owner Menu	Enter password to assess the following actions: <ul style="list-style-type: none"> • Adjust and Set ProBalance Thresholds • Toggle Hood Start Settings • Enable/Disable Sonar
  or	Coats Service Menu	Your COATS® Service Technician may assess this for information to help diagnose service concerns. A password is required.
  or	General Settings Menu	Access these screen to get the following: <ul style="list-style-type: none"> • Perform Machine Calibration • Lock the screen for cleaning • Adjust the volumn level.
	Exit Menu Screen	Press this icon to exit the settings screen and return back to the main screen.

Power Switch

The ON/OFF switch location (figure 7) is on the back of the balancer; below the weight tray.

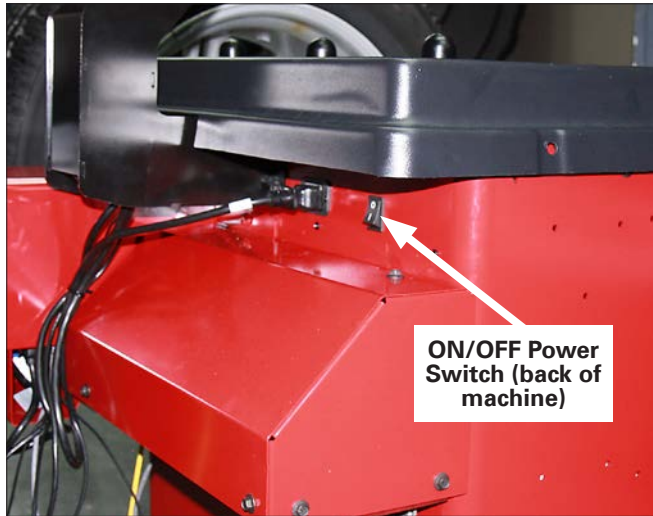

Figure 7 - On/Off Switch

Weight Tray

Weight pockets are laid out so that wheel weights are easily accessible. Use the weight tray studs for handy storage of wheel mounting adapters.



Figure 8 - Balancer Weight Tray

Using The Offset Arm

When not in use or when prompted by the balancer instructions, store the offset arm in the home position as shown in figure 9.

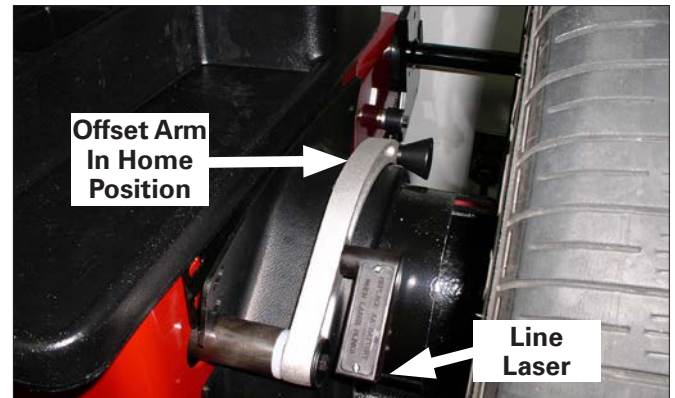

Figure 9 - Location of Offset Arm (Stored In Home Position) and Laser Locator

Use the offset arm gauge (figure 10) to automatically measure the distance from wheel to machine and the wheel diameter.



Figure 10 - Automatic A & D Measurement At Clip-on Weight Location

Be sure to place the offset arm on the wheel flange at the clip-on weight location as shown figure 11. (for C1 and T1 measurements)



Figure 11 - Clip-on Weight Location Viewed on a Cut-Away Rim for Clarification.

Note: Use the offset arm to automatically measure the A & D dimension for all balancing modes except Patch Static; see page 25 Patch Weight Balance (if equipped).

Note: Refer to page 24 to measure the A dimension manually using the offset arm.

If the T2 Tape (hidden Tape-A-Weight) location is selected, use the offset arm to enter A2 & D2 measurements automatically. (see figure 14) After the A & D measurement is entered, move the arm from the C1 clip-on weight location to the inner area of the wheel; up against the rim at the outboard weight placement location (see figures 12 and 13). Wait for the BEEP.



Figure 12 - Hidden Weight Location Viewed on a Cut Away Rim for Clarification.

Note: The T2 Tape Direct Select™ Weight position is the only mode that requires the A2 & D2 dimension measurements.

Note: Use laser locators for correct positioning of the T2 Tape Direct Select™ Weight position, refer to pages 16-17.

Important: The A2 measurement must be at least 2 inches greater than the A1 measurement.

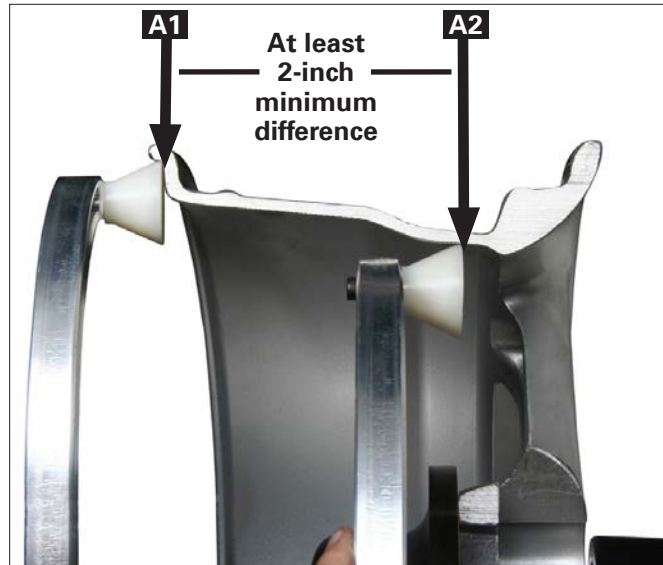

Figure 13 - T2 Tape (Hidden Tape-A-Weight), Keep At Least 2 inches Between A1 and A2 Measurement

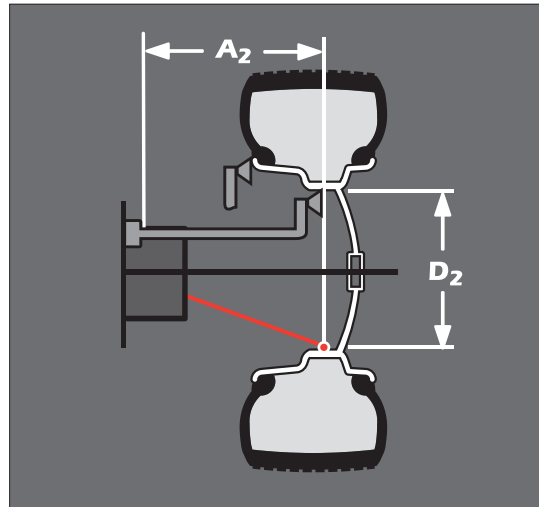

Figure 14 - T2 Tape (Hidden Tape-A-Weight), Data Entry Diagram

Using The Laser Locator

If the T2 Tape (hidden Tape-A-Weight) location is selected, use the laser locator to point to the desired hidden weight location (figures 15).

1. Rotate laser locator knob to position the laser dot outboard at the desired T2 Tape (hidden Tape-A-Weight) location.

Note: Choose a weight position as far inward (in the rim) as wheel allows (figure 15a). If weight can't be placed outside of wheel center, then Dynamic Balancing can't be calculated.

Note: The T2 Tape Direct Select™ Weight position is the only mode that requires the A2 & D2 dimension measurements (figure 12).

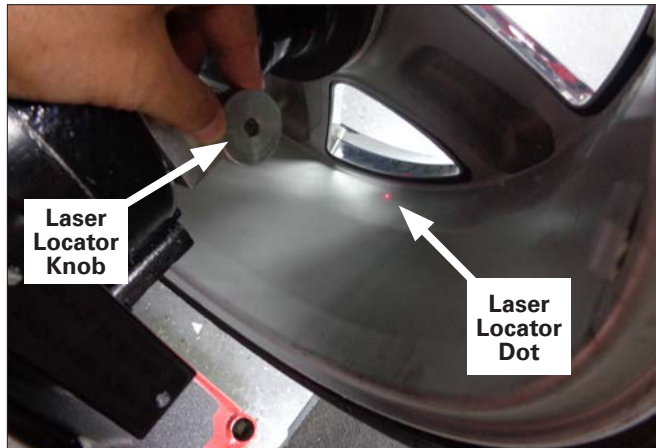

Figure 15 - Positioning Laser Dot At T2 Tape Hidden Weight Location (A2)

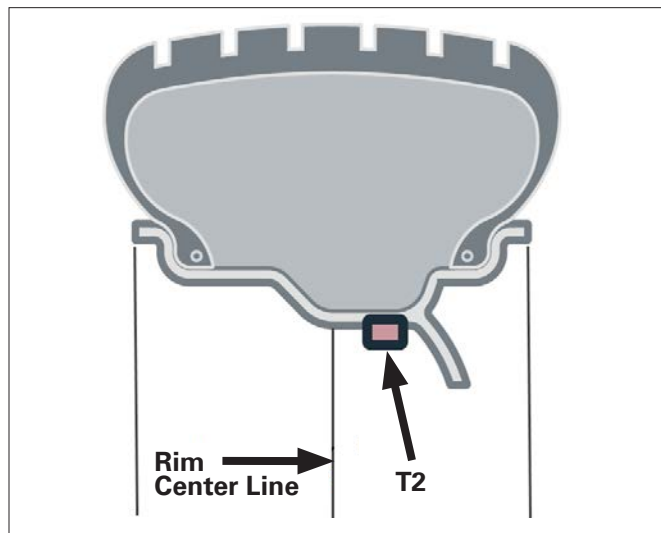

Figure 15a - Weight As Far Inward On Rim As Possible

Using The Line Laser

If the T2 Tape (hidden Tape-A-Weight) location is selected, use the line laser to align the offset arm with the laser locator dot (figures 13 and 14); entering A2 & D2 measurements automatically.

Press switch on the laser housing and it turns ON for 10 seconds, then automatically shuts OFF so you do not have to hold the button. The line laser is powered by a AA battery. When the battery is low the laser blinks indicating that it is time to replace the battery.

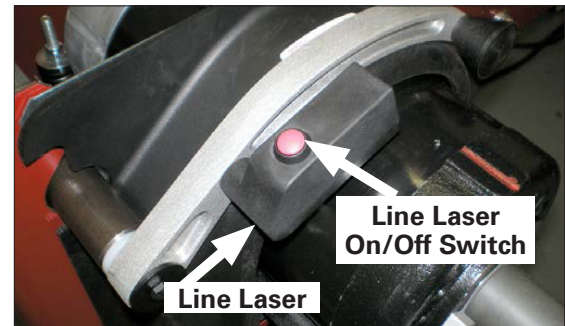

Figure 16a - Laser Locator ON/OFF button

1. Grasp arm at the line laser and pull out and up to the wheel flange C1 (figure 11). Hold arm still at the clip-on weight location and wait for BEEP.

2. Press button on line laser to activate the beam.

3. Move arm to inner area of wheel and align line laser beam with laser locator dot (figure 16b). Hold arm still, up against the rim, in the same plane as the T2 Tape (hidden Tape-A-Weight) location (figure 12 and 13) and wait for BEEP. Refer to figure 16b.

Note: T2 must be selected to activate Dot Laser. The line laser remains on for ten seconds after its button is pushed.

Note: The balancer (if equipped) automatically selects the T2 Tape location, when the second inner area weight location is entered before returning the arm to home position.

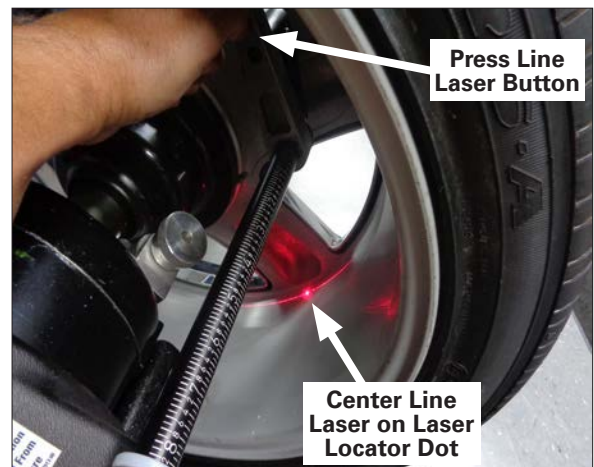

Figure 16b - Positioning Line Laser Beam At T2 Tape Hidden Weight Location (A2)

Laser Guided Operation™ System



The operator may automatically select (if equipped) or Direct Select™ the T2 Tape Laser Location, activating the Laser Guided Operation™ feature (see page 15 for automatic selection and page 22 for button selection). This Direct Select™ weight location is used when placing hidden adhesive weight at the inner area of the wheel and is the required weight location selection for the Behind Spoke mode (see page 26).

Follow these steps to use the Laser Guided Operation™ feature for accurate placement of hidden Tape-A-Weights:

Important: Only use the Direct Select Weight position Clip 1 or T1 Tape and T2 Tape (location activated). Refer to Using The Offset Arm on pages 14 - 15 and Using The Lasers on page 16.

1. Begin by mounting the wheel assembly on the balancer shaft.

2. Direct Select™ T2 Tape as the outboard weight location.

Note: The laser locator dot activates and blinks.

3. Rotate the laser locator knob to position the laser locator dot at the desired weight location. See figures 15 and 16.

Note: Choose a weight position as far inward (in the rim) as wheel allows.

4. Using the offset arm, enter the A and D wheel measurements, wait for BEEP. Before returning arm to home position, turn ON the Line Laser, move arm to inner area of wheel and position the line laser beam at the T2 Tape laser locator dot position; ensure A and D Arm is in contact with Rim, wait for BEEP. Return arm to home position.

5. Lower hood; wheel spins.

6. When the inboard unbalance is displayed, the inboard center bar highlights. Attach inboard corrective weight at top-dead-center.

Note: If an inboard corrective weight is not required then the wheel will stop at the outboard corrective weight location (if equipped) or manually if not.

7. Press NEXT to rotate wheel to outboard corrective weight location where the outboard center bar is steady and the two bars on either side blink.

Note: The laser locator dot will stop blinking and turn solid when wheel reaches correct weight position.

Note: This Laser Product is designated as Class 2 during all procedures of operation.

8. Center and attach the outboard corrective weight at laser dot location as shown in figure 17.

9. Respin tire/wheel to check balance.

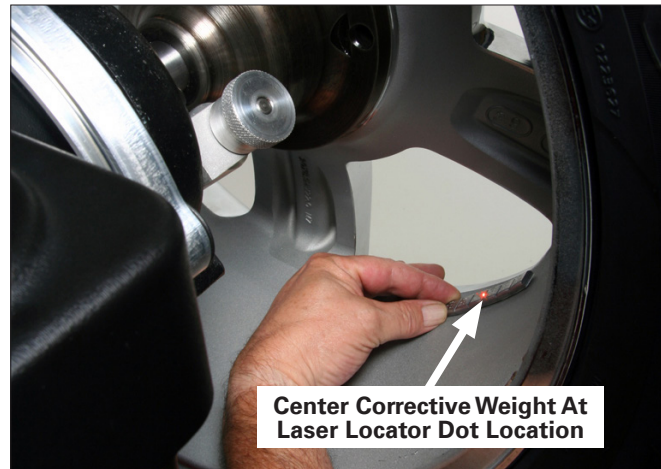

Figure 17 - Centering Corrective Hidden Weight at Laser Dot Location.

Laser Identification



On/Off

Laser Aperture

Arm Line Laser

Line Generator
Wavelength 650nm
Emission type: CW
Laser Power for
Classification <500uW
Divergence<2mRad x
30°



Laser Aperture

Dot Laser

Dot Generator
Wavelength 655nm
Emission type: CW
Laser Power for
Classification <700uW
Divergence<1mRad

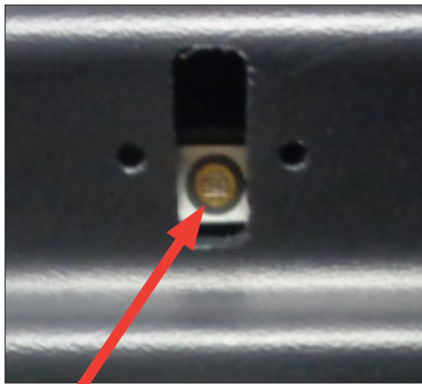

Laser Aperture

12 O'Clock Laser

Line Generator
Wavelength 650nm
Emission type: CW
Laser Power for
Classification <300uW
Divergence<2mRad x 75°

Using the Hood Sonar (Width Sensor - if equipped)

When prompted by the balancer instructions, use the hood sonar (width sensor, figure 18) to enter wheel width measurement automatically. Lower balancer hood to enter the measurement.



Figure 18 - Tire Width Sonar Located Inside Hood

Note: Refer to page 23 to measure the W dimension manually using the plastic calipers.

Hood (Wheel Guard)



Never raise up the wheel guard before the wheel has come to a stop. Keep hair, loose clothing, fingers and all parts of body away from moving parts.

If, due to a fault in the machine, the wheel keeps spinning permanently, switch the machine OFF at the master switch or by unplugging the plug from the power supply. Wait until the wheel stops before opening the wheel guard.

Auto Wheel Positioning (if equipped)



Keep hair, loose clothing, fingers and all parts of body away from moving parts.

The balancer's auto positioning feature stops the wheel automatically at the corrective weight location. The wheel is spun and unbalances are measured and displayed. The inboard center bar highlights as the balancer stops the wheel at the inboard corrective weight location (top-dead-center). (If an inboard corrective weight is not required, then the wheel will stop at the outboard corrective weight location.) Press NEXT. The outboard center bar highlights as the wheel automatically moves and stops at the outboard corrective weight location (top-dead-center).

Pressing NEXT moves the wheel automatically to the next corrective weight location. Pressing STOP & EXIT releases the wheel so that it can be manually positioned.

After several minutes of inactivity, the auto positioning feature will turn itself OFF. Press NEXT to make the feature activate again.

12 o'clock Laser

When wheel is indexed to either the Clip 1 or Tape 1 inboard corrective weight location, then the 12 o'clock laser activates. Use the 12 o'clock laser line to aid in corrective weight placement by centering the weight to the laser line as shown in figure 19.



Figure 19 - Centering Corrective Weight At 12 o'clock Laser Line Location

Display Mount

When the display mount is in the folded position, the display rests securely on the weight tray, as shown in figure 20. Use locking screws on the display mount to secure it in the upright position, as shown in figure 21.

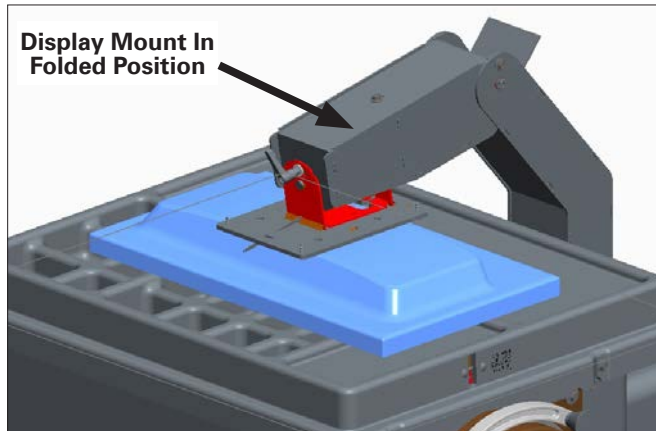

Figure 20 - Display Mount In Folded Position

The locking lever allows the user to position the display front or right; and then lock in place. Positioning the display makes it easier to view and touch, while operating the wheel balancer.

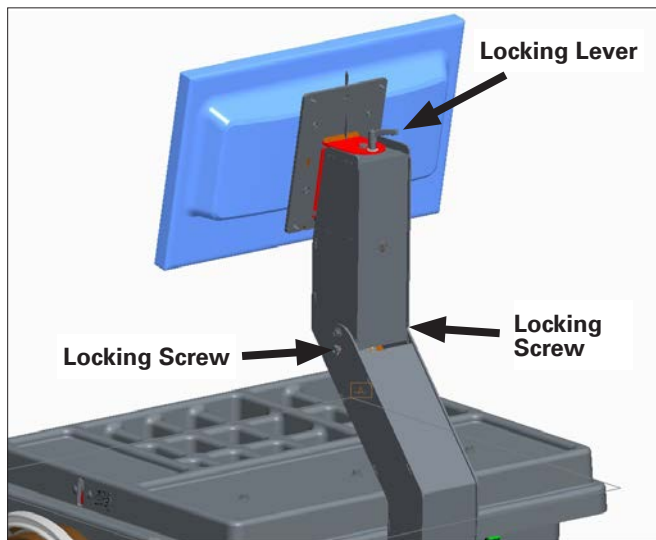

Figure 21 - Display Upright In Front Position

Control Panel (if equipped)

The balancer control panel is a durable panel (figure 22). To enter a function, use your finger to press the appropriate function key.



Figure 22 - Press Control Panel Keys

Note: Only press the control panel with **your fingers**. Never use the weight hammer or other pointed objects to press on the panel.

Touchscreen (if equipped)

To enter a function, use your finger to press the appropriate function icon.



Figure 23 - Press Touchscreen Functions

Note: Only press the touchscreen with **your fingers**. Never use the weight hammer or other pointed objects to press on the screen.

Mounting Wheel On Balancer Shaft



Avoid back injury, seek assistance when lifting heavy tire/rim assemblies onto the balancer shaft.



Failure to tighten the hub nut properly may result in the wheel dismounting, causing personal injury and property damage.

Select the most appropriate mounting method for the wheel you are balancing. Using the proper method ensures secure mounting and safe balancer operation, and prevents damage to the wheel.

On most wheels, the inner side of the wheel hub usually has the most uniform surface for wheel balancing. Always center the wheel by the most uniform shaped side of the hub to achieve the most accurate balance.

Regardless of mounting type, on standard units, always make sure that the wheel is forced firmly against the shaft and faceplate, and that the hub nut engages the threaded shaft for at least four complete turns. To assist in centering the wheel properly, rotate the wheel and the shaft while tightening the hub nut.

Standard Back Cone/Collet Mounting

Most original equipment and steel wheels can be mounted properly using this method. The wheel is centered on a cone/collet from the inner side of the hub.

1. Place the cone spring onto the balancer shaft with the large end towards the faceplate.
2. Select the cone/collet that best fits the center hole in the wheel. Slide the cone/collet onto the shaft with the large end towards the cone spring.
3. Lift wheel onto the shaft and center it on the cone/collet.
4. Attach pressure cup to hub nut. Install the hub nut assembly onto the shaft and tighten it securely against the wheel. The wheel must be forced firmly against the faceplate. The hub nut must engage the threads for at least four full turns

Note: Use a nylon spacer (protective ring) to protect custom wheel finishes.

Note: If the hub nut will not tighten completely, use the standard front cone mounting method (figure 25).

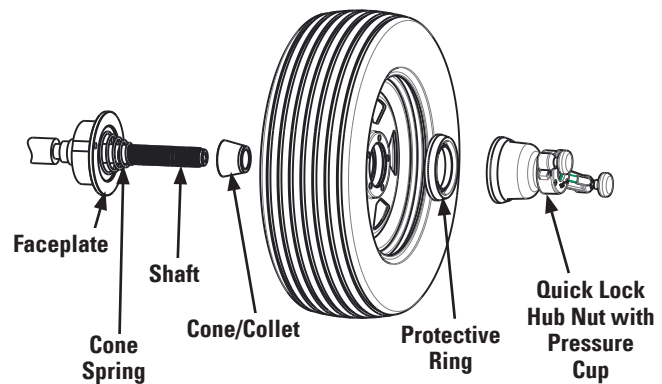

Figure 24 - Standard Back Cone/Collet Mounting

Optional Front Cone/Collet Mounting

A wheel should be centered by the outer side of the hub only when the inner surface will not provide an accurate surface to center on, and the front will.

1. Select the cone/collet that best fits the center hole in the wheel.
2. Lift the wheel onto the balancer shaft and slide it back against the faceplate.
3. Slide the cone/collet onto the shaft and into the center hole of the wheel. You will need to lift the tire to seat the cone in the center hole.
4. Install the hub nut (without pressure cup) onto the shaft. Tighten it securely against the cone/collet. The hub nut must engage the threads for at least four full turns.

Note: If the hub nut will not tighten completely because of a lack of threads, use an additional cone/collet as a spacer between the mounting cone/collet and the hub nut. The wheel must be forced firmly against the faceplate.

Note: Do not front cone chrome or clad wheels.

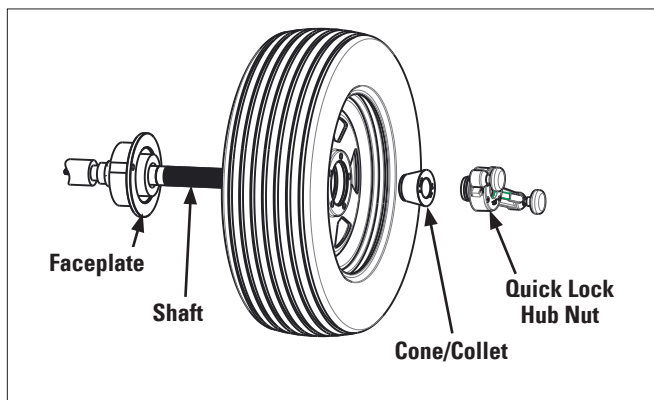

Figure 25 - Front Cone/Collet Mounting

Alternate Mounting

If the wheel has a protruding outer hub which will not permit the use of the pressure cup, or the cup will not permit the hub nut to engage at least four turns of the shaft, this alternate method should be used.

1. Place the cone spring onto the balancer shaft with the large end towards the faceplate.
2. Select the cone/collet that best fits the center hole in the wheel. Slide the cone/collet onto the shaft with the large end towards the faceplate.
3. Lift wheel onto the shaft and center it on the cone/collet.
4. Use the small nylon spacer (no-mar ring) or a centering cone/collet to press against the outer wheel hub.
5. Install the hub nut (without the pressure cup) onto the shaft. Tighten securely.

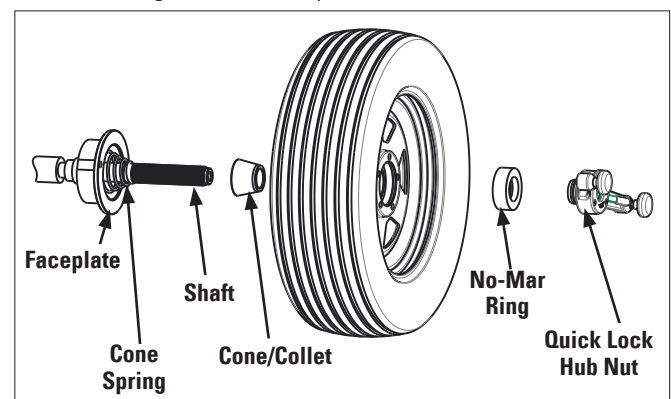

Figure 26 - Alternate Mounting

Direct Select™ Weight Placement Location

Weight Placement Options

When the machine is turned ON, the balancer defaults to a 2-plane dynamic mode using standard clip-on wheel weight locations (Clip 1 and Clip 2) and wheel dimensions. Before setting wheel dimensions and spinning the wheel, set alternate weight placement locations as follows (see also figures 27 and 28):

Clip 1 (default) - select this location, dynamic or static mode, to place a standard clip weight on the inboard rim flange at 12 o'clock (top dead center).

T1 Tape - select this location, dynamic mode, to place an adhesive weight on the inboard side of the wheel. This is the horizontal plane at the outer edge of the rim at 12 o'clock (top dead center).

Patch - select this location, static mode, for a patch weight centered inside the tire. See Patch Weight Balance on page 25 for further details (available on certain models).

T2 Tape - select this location, dynamic or static mode to place the adhesive (hidden) weight on the outboard side of the wheel. This is the horizontal plane at the inner area of the rim.

T3 Tape - select this location, dynamic mode, to place an adhesive weight on the outboard side of the wheel that is the horizontal plane at the outer edge at 12 o'clock (top dead center).

Clip 2 (default) - select this location, dynamic mode, to place a standard clip weight on the outboard rim flange at 12 o'clock (top dead center).

Direct Select™ Control Panel Models

1. Press a Direct Select key (see page 10) to enter an alternate weight placement location on the wheel. The selected weight location on the wheel cross-section diagram illuminates.

2. Press EXIT to return to the main screen.

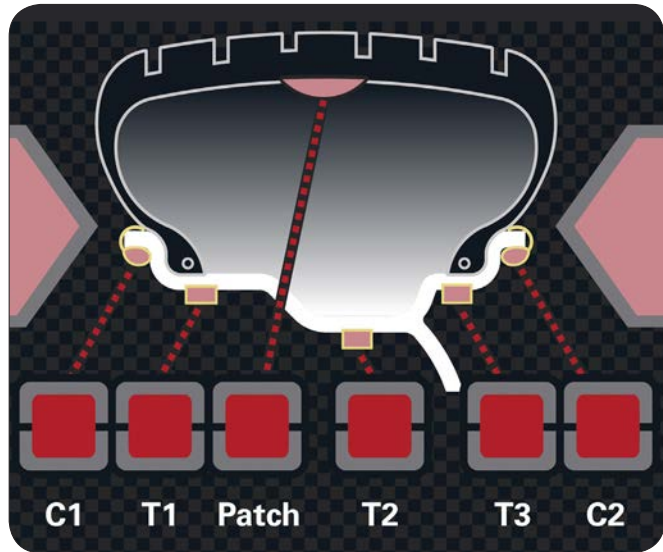



Figure 27 - Direct Select™ Weight Icons And Wheel Cross-section Diagram

Direct Select™ Touchscreen Models

1. Press the Direct Select icon  (see page 12) to go to the Direct Select screen. Press a Direct Select icon to enter an alternate weight placement location on the wheel. The selected weight location on the wheel cross-section diagram highlights.

2. Press EXIT to return to the main screen.



Figure 28 - Direct Select™ Weight Icons And Wheel Cross-section Diagram

Setting Wheel Dimensions (DIM)

Before a wheel can be balanced, wheel dimensions must be entered into the balancer computer.

Definition of Dimensions (DIM)

A = Offset

The distance measured from the balancer ("0" on offset arm) to inner plane of the rim (inner weight location).

W = Width

The width of the wheel at the rim flanges, measured with the calipers as shown in figure 31.

Note: Only use calipers provided by the wheel balancer manufacturer because others may be different.

D = Diameter

The diameter of the wheel as indicated on the tire.

Note: A thick flange, on some aluminum wheels, can effect the measured diameter. For example, a 16-inch rim can have a measured diameter of 15.5-inches.

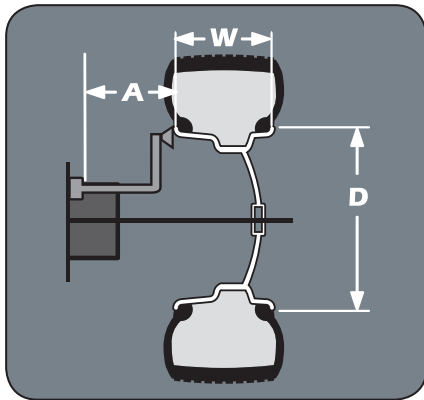

Figure 29 - A, W, and D Tire Dimensions

A2 = Offset

The distance measured from the balancer ("0" on offset arm) to outer plane of the rim (outer weight location). Used only for adhesive weight location.

D2 = Diameter

The diameter as measured at the A2 weight location. Used only for adhesive weight location.

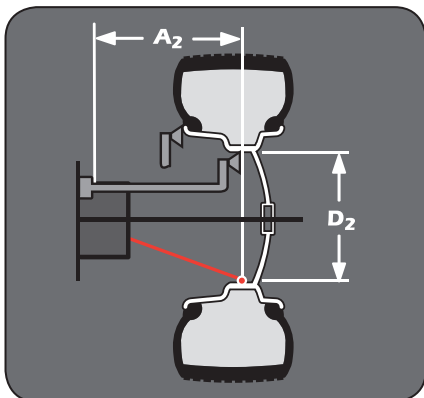

Figure 30 - A2 and D2 Tire Dimensions

Basic Wheel Data Entry

1. Direct Select™ an inboard weight location (Clip 1, or T1 Tape) and an outboard weight location (T2 Tape, T3 Tape or Clip 2).

2. Position offset arm at clip weight location; wait for BEEP (A & D enters automatically).

If the T2 Tape location is selected, then move the offset arm from the clip weight location to the inner area of the wheel; up against the rim at the outboard weight placement location; wait for BEEP (A2 & D2 enters automatically).

3. Return offset arm to the home position.

4. For Automatic Measurement — Lower balancer hood to enter the W measurement automatically using the hood sonar (width sensor) and spin wheel.

For Manual Entry — Use plastic calipers to measure wheel width. Press W key/icon. Use keypad to enter Width value (between 2.0 and 20.0 inches)

Entering Wheel Dimensions Manually

Information entered into the balancer software for A, W, and D can be changed anytime during a balancing procedure by entering the measurements manually. The balancer will recalculate weights and positions based on the new measurements.

Wheel Offset - A

1. Press the A (wheel offset) icon.
2. Position offset arm at weight location on wheel and read the number on the offset arm gauge, at the cabinet (this is the correct offset A DIM).
3. Using the keypad, enter the A measurement value. On touchscreen models, include the decimal.

Wheel Diameter - D

1. Press the D (wheel diameter) icon.
2. Inspect mounted tire sidewall to determine the exact diameter that is printed on the tire.
3. Using the keypad, enter the D measurement value to match the tire sidewall size. On touchscreen models, include the decimal.

Note: Auto entry is the preferred method for entering A2 and D2. However, on control panel models to manually enter A2, press Shift+A and to enter D2, press Shift+D. (see figure 30)

Wheel Width - W

1. Press the W (wheel width) icon.
2. Use the plastic calipers provided with the wheel balancer to measure the wheel width. (see figure 31)



Figure 31 - Caliper Placement On Wheel

3. Using the keypad, enter the W measurement value to match measured caliper width of mounted rim. On touchscreen models, include the decimal.

Balancing A Wheel Using Direct Select™

A variety of wheel configurations can be balanced using this wheel balancer. Read through this section, it will help in determining which balancing mode and options are best suited for certain wheel assemblies.

Remember: As with any balancing procedure, first remove any weights attached to the wheel, inspect the tire and wheel, and select the most appropriate balancer mounting method before beginning.

Dynamic Balancing



Choose a dynamic balance to balance a wheel using two planes for correction. Select the weight option that best fits the available weight locations on the rim.

Clip-on Weights - The standard default; used for most passenger tire/wheel assemblies using the most common location for corrective weights. Clip-on weights are placed on the inner (inboard) and outer (outboard) rim flanges.

ALUS (Aluminum Wheels) - To balance aluminium wheels you usually use a self-adhesive weight location that is positioned differently from the clip-on weight position(s) used in standard balancing. Be sure to use the appropriate wheel data entry method since the balancer calculates unbalance values based on the wheel dimension measurements (DIM) entered for the tire/wheel assembly.

Note: When the machine is switched ON, a standard dynamic balance using clip-on weight locations is the default setting.

Figure 32 - Dynamic Balance Weight Locations

Static Balancing

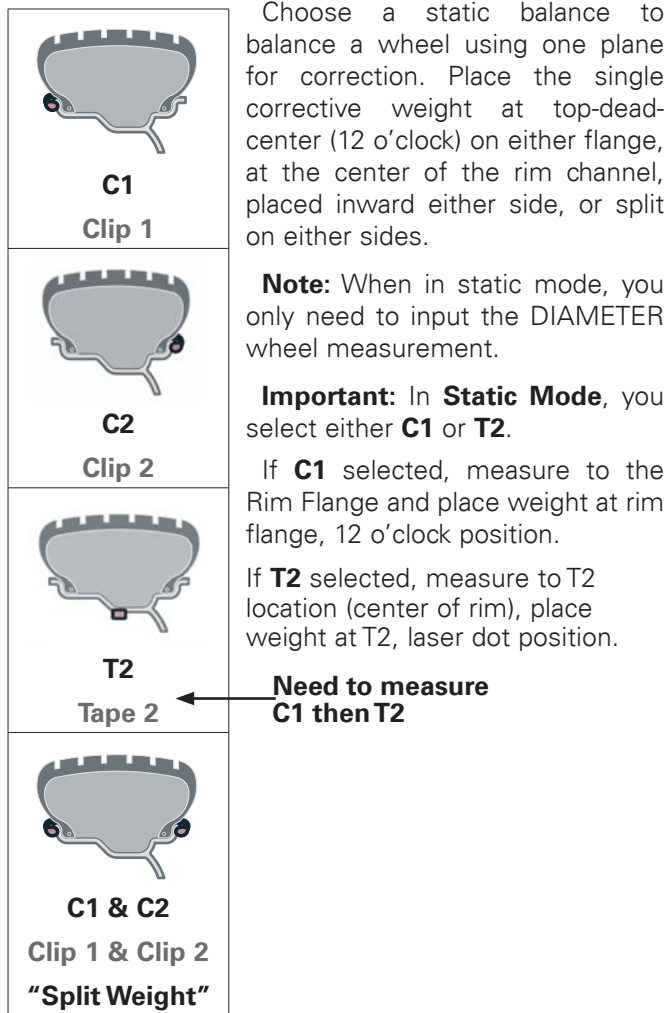

Choose a static balance to balance a wheel using one plane for correction. Place the single corrective weight at top-dead-center (12 o'clock) on either flange, at the center of the rim channel, placed inward either side, or split on either sides.

Note: When in static mode, you only need to input the DIAMETER wheel measurement.

Important: In **Static Mode**, you select either **C1** or **T2**.

If **C1** selected, measure to the Rim Flange and place weight at rim flange, 12 o'clock position.

If **T2** selected, measure to T2 location (center of rim), place weight at T2, laser dot position.

Patch Weight Balance (if equipped) - Use a static patch weight balance when there is a very large unbalance in a tire assembly or if a very large tire has a large unbalance. A weighted balance pad (patch weight) is placed inside the tire in the center to compensate for the large unbalance.

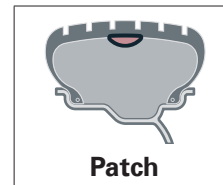

Direct Select Weight position **Patch** (weight location illuminates). At this location place the corrective weight amount at top-dead-center.

Have the following items handy: measuring tape and various patch weight sizes.

Note: Before proceeding with Patch Weight Balance, it is recommended that you use the Match Balance (Optimization) - If Equipped procedure first, see page 28, in order to use the smallest patch weight.



The Patch Weight Balance involves the loosening of tire beads and the inflation of a tire. Training is necessary in tire changer operation and understanding the dangers involved during bead seating and tire inflation before attempting this stage of the Patch Weight Balance procedure. Read the operators manual supplied with the tire changer and consult a supervisor.

The patch weight balance steps are as follows:

1. Direct Select™ weight position Patch. The balancer automatically sets itself for a static balance.

2. Measure the outside tire diameter, see figure 34, and enter this diameter manually using the keypad.

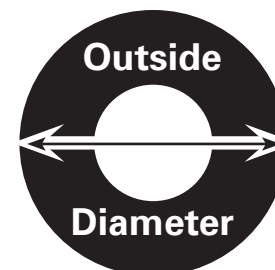

Figure 34 - Measure Outside Tire Diameter

3. Spin the wheel.

4. Rotate the wheel until the center weight position bar highlights. Next, mark the tire and rim at 12 o'clock. Then remove the wheel assembly from the machine.

5. Disassemble the tire and rim. Place patch weight in the tire at location marked on the tire. Reassemble tire and rim matching the marks on the tire and rim.

6. Complete by balancing the wheel assembly following normal procedures.

Corrective Weight Placement

After the wheel spins and unbalances are measured and displayed, the corrective weight amount appears on the weight display windows for inboard and outboard weight locations. Bars appear on either side of the wheel cross-section graphic to aid in positioning the wheel for corrective weight at the application point.

After a measurement cycle, if not using auto lock, rotate wheel until the center weight position bar blinks, indicating the correct weight placement position is at top-dead-center. If the unbalance is less than the chosen threshold value, 000 appears instead of an unbalance value to indicate that, on that particular side, the wheel is in tolerance.

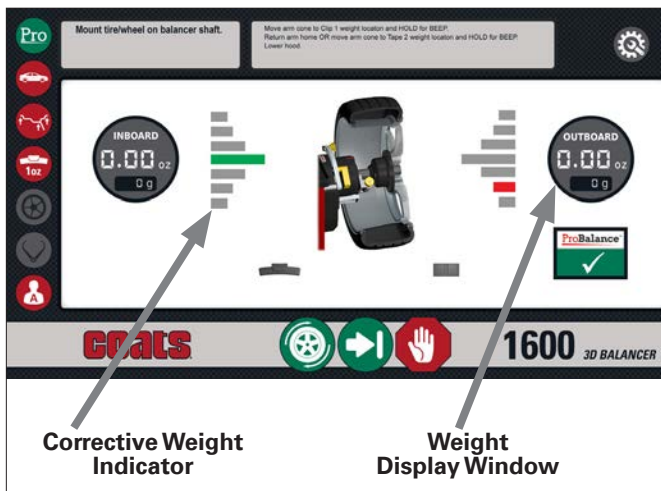

Behind Spoke Mode

"Splitting" the T2 Tape corrective weight amount is used to hide the adhesive weight behind two rim spokes.

1. When the unbalance is displayed, rotate wheel until inboard center bar blinks. Attach inboard corrective weight at top-dead-center.

2. Press NEXT to rotate wheel until outboard center bar blinks.

3. Select the Behind Spoke icon to begin the behind spoke animation sequence. A SPOKE 1 icon will display on the dashboard.

4. Rotate wheel toward front until the first spoke is at the laser dot; press SPOKE 1. Now a SPOKE 2 icon will display on the dashboard.

5. Rotate wheel toward rear until the second spoke is at the laser dot; press SPOKE 2. Now at the spoke 2 location, the laser dot stops blinking.



Figure 35 - Spoke 1 and Spoke 2 Locations On Either Side Of Original Outboard Weight Location

6. Attach the spoke 2 outboard corrective weight at the laser dot behind spoke 2.

7. Press NEXT to rotate wheel to spoke 1 location.

8. Attach the spoke 1 outboard corrective weight at laser dot behind spoke 1; then press NEXT.

9. Press SPIN to check tire/wheel balance.

ProBalance Technology™ On Touchscreen Models

Any excessive residual unbalance is detected when using ProBalance Technology mode, see Balance Mode Icons, page 13. When activated, an ON (enabled) icon will display on the dashboard, see figure 36.

Note: ProBalance is only available when the balancer is set in car mode and round off mode.



Figure 36 - ProBalance Technology Enabled Icon

1. After correcting for dynamic unbalance, and excessive residual unbalance is detected over tolerance, then a PUSH icon button will display on the dashboard (figure 37). Press the button.



Figure 37 - Press To Correct For Excessive Residual Unbalance

2. The balancer stops and automatically positions the wheel at the ProBalance correction location. Now attach the specified corrective weight amount (figure 38) at the 12 o'clock position in the center of the rim channel (as displayed in graphic on wheel balancer).



Figure 38 - ProBalance Corrective Weight Amount

3. Respin tire/wheel to check balance. If the weight amount and placement are correct, a check will appear.



Figure 39 - ProBalance Technology Success Button

Match Balance (Optimization) - If Equipped



The Match Balance involves the loosening of tire beads and the inflation of a tire. Training is necessary in tire changer operation and understanding the dangers involved during bead seating and tire inflation before attempting this stage of the Match Balance procedure. Read the operators manual supplied with the tire changer and consult a supervisor.

On certain models, the Match Balance (Tire/Rim Weight Optimization) procedure is used to determine the best mating of tire and rim that will result in the least amount of total unbalance of the assembly. It requires two spins and two rotations of the tire on the rim. Match Balance may be needed when:

- The customer complains of ride problems.
- The balancer calls for Total Static weights in excess of 3 ounces (85 grams) on passenger car tires.

Note: A high unbalance may indicate the improper mounting of the assembly on the balancer, or a rim that is out of round or misformed, or a tire with a bubble or other problem. If the unbalance is excessive, it may be prudent to replace the rim, the tire, or both. If either is replaced, do not continue with Match Balance. Balance the new tire and rim and evaluate the readings.

Match Balance Mode

If you choose to use Match Balance to correct for a condition, such as a large static unbalance, then **follow the information box instructions for the MATCH BALANCE procedure as outlined in the following steps.**

Note: Use this procedure only after the wheel has spun and the corrective weight amount is displayed.

Note: Use the total static display option. See BALANCE OPTIONS, page 13, for further details.

1. Press and hold the SHIFT key and press 5 to select the Match Balance mode; a " 1 " will appear in the outboard weight display.

2. Raise the hood and rotate the wheel until the valve stem is at top-dead-center. Mark the tire sidewall at the valve stem.

3. Press 1 on the control panel; a " 2 " will appear in the outboard weight display.

4. Remove the wheel assembly from the balancer.

5. Using a tire changer, rotate the tire 180 degrees on the rim.

6. Remount wheel assembly on the balancer. Press 2 on the control panel; a " 3 " will appear in the outboard weight display.

7. Lower the hood and press START. The wheel spins.

8. When the wheel stops spinning, raise the hood and rotate the wheel until the valve stem is at top-dead-center.

9. Press 4 on the control panel.

Weight amounts appear on the control panel. The amount in the inboard weight display is the weight imbalance for the rim. The amount in the outboard weight display is the weight imbalance for the tire. Use these weight amounts to determine the suitability of the rim or tire.

Note: If either the rim or the tire weight amount is close to zero or zero then using Match Balance will not affect the total unbalance of the assembly.

10. Rotate the wheel until the outboard weight position bar flashes. Mark the tire at top-dead-center.

11. Remove wheel assembly from balancer.

12. Using a tire changer, rotate the tire until the mark is aligned with the valve stem.

13. Remount the wheel assembly on the balancer.

14. Press NEXT or START to exit Match Balance. Select a balancing mode and balance wheel assembly.

Calibration

Machine Calibration

1. Enter the MACHINE CALIBRATION mode.
2. Enter the D dimension (include decimal point, example: 16.0 for a 16-inch wheel). Press ENTER.
3. Lower the hood and press SPIN.
4. After spin, raise the hood. Attach 4-ounce calibration weight to the outside flange at top-dead-center.



Figure 40 - Calibration Weight On Outside Flange At Top-Dead-Center

5. Lower the hood and press SPIN

Important: It is critical that the inner weight be placed accurately to achieve proper calibration. If the calibration weight is not moved from the outside flange directly across to the inside flange, an inner weight placement error will occur. To correct, follow the balancer instructions.

6. After spin, raise the hood. Move the 4-ounce calibration weight directly across and attach it on the inside flange at top-dead-center (12 o'clock position).



Figure 41 - Calibration Weight Moved (Directly Across) To Inside Flange

7. Lower the hood and press SPIN.

Note: Rotate laser dot toward inner flange.

8. After spin, raise the hood. Rotate wheel to line up/center of 4-ounce calibration weight with laser dot. Hold position while pressing NEXT.

9. Press NEXT; then press EXIT.

Note: On control panel models complete the machine calibration procedure. Then press and hold the SHIFT key and press 3 to access the CAL ARM mode.

10. Bring the cone edge of the arm precisely to the outer edge of the faceplate and hold it there (through step 12) while pressing the NEXT. (If necessary to reach the faceplate accurately, loosen the calibration wheel temporarily.)

11. With arm cone still at the edge of the faceplate, enter the A dimension (include decimal point) read off the arm gauge; see figure 41. Press ENTER.

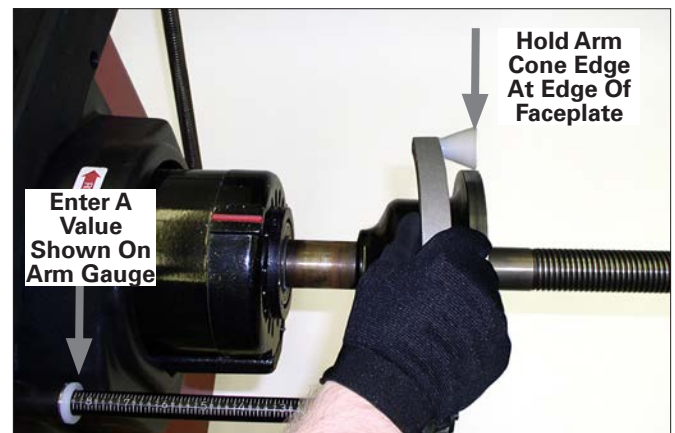

Figure 42 - While Holding Arm Cone at Faceplate Edge, Enter A

12. Move arm to its home position and press NEXT.

13. Move arm to clip-on weight location on rim flange and hold it there (through step 16). Wait for voltage reading to stabilize, then press NEXT.

14. With arm still at clip-on weight location, enter the D dimension (16.0 for a 16-inch wheel) that is the diameter of the tire. Press EXIT.

15. While still holding the arm at the wheel's clip-on weight location, enter the A dimension (include decimal point) read off the arm gauge. Press ENTER

16. Return the arm to home position; calibration is complete. Press EXIT. Press STOP & EXIT to go back to the main screen.

Maintenance Instructions



Use caution, this is an electrical device. Exposing the balancer to water, either by hose or bucket, or by exposure to rain or snow, may cause risk of shock or electrocution to operator or bystanders. Place, store, and operate the balancer only in a dry, sheltered location.



Do not hose down with water or bucket wash the balancer. Extensive damage to the balancer will result. Sensitive electronic components, wiring harnesses, and other devices housed in the balancer are not intended to be exposed to water.

The balancer requires only minor maintenance to keep the unit operating properly.

1. Keep the touchscreen clean and clear. Use screen wipes, or a clean soft damp cloth are the only safe and acceptable methods to clean the unit's touchscreen. Do not use cleaners or solvents which leave oily or filmy residues behind that will void the touchscreen's factory warranty.

2. Keep the adapters, cones, faceplate, threaded shaft, pressure cup, and hub nut clean. Grease and dirt buildup will cause inaccurate balancing and premature wear. Clean these items at least once a day with a vaporizing solvent.

3. Clean weight tray and any accessory studs, pegs, or storage shelves with a mild detergent. Weights stored in a dirty tray may pick up grease and dirt which may keep them from securely attaching to the wheel.

4. Keep the area around and under the balancer clear. Remove any tools or other items that are leaning against the balancer. Remove any items that may cause the balancer to not sit level. Be particularly cautious of new or used wheel weights on the floor, as they may cause personal injury due to falls.

5. Use only COATS® accessories. Accessories from other manufacturers may not fit or function properly, and may damage the balancer.

6. The A & D line laser maintenance is limited to battery replacement and line adjustment using the set screws.

7. To keep the balancer lasers in compliance, do not maintain them.

Diagnostic Procedures

After Balance Vibration Problems

If vibration is still present after balancing the wheels and driving the vehicle on smooth pavement, remove the wheels and recheck the balance. If a wheel is unbalance the cause maybe:

- Wheel was not mounted/centered correctly on the balancer.
- A weight has come off the wheel (possibly the wrong clip style). Remove the other weights from the wheel and rebalance.
- Foreign material inside the tire. Remove the tire from the wheel, remove the foreign material, and remount. Remove wheel weights and rebalance the wheel.
- Stones or other foreign objects caught in the tire tread or rim. Remove the objects. Check and rebalance if needed.

If the balancer still indicates the wheels are balanced to within 0.05 ounces (1.42 grams) on both inner and outer displays, the problem is not in the balance of the wheels. Check the following possible sources of vibration:

- Tire pressure. Bring all tires up to the recommended PSI.
- Radial or lateral runout in the tire or wheel. Replace the damaged part.
- Unbalance in wheel covers or trim rings. Remove the wheel covers or trim rings and test drive. If the vibration is gone, remove the shaft and use an appropriate adapter to mount the wheel to the balancer. Balance the wheel with the wheel cover or trim ring attached to the wheel.
- Incorrectly mounted tire and wheel. Remount correctly.
- Damaged rim bolt holes. Replace rim.
- Worn universal joints. Replace as required.
- Drive shaft unbalance or damaged. Balance, repair, or replace.
- Unbalance in brake rotor(s) or drum(s).
- Suspension out of alignment. Align the vehicle and replace any damaged or worn parts.

Troubleshooting

A COATS® Service Technician may ask for information to help diagnose service concerns (please contact COATS directly at 1-800-688-9240 for the Certified Service Partner nearest you). Conveying this information to your service technician prior to servicing can help to expedite service to your equipment. Although much of the diagnostic information aids your COATS Service Technician, several remedies for balancer misfunctions are available to the operator.

Error Messages - One of the following error messages, shown in the display windows, may appear indicating a problem with the balancer.

Note: Always, exit error message and repeat the procedure to see if the error is eliminated.

Error	Description
E1	Spin up is too slow - Verify power supply to balancer and motor connection
E2	Spin up time too long - Check Wheel DIA and power supply - press STOP - EXIT
E3	No rotation signal - Check motor, encoder function and wiring -press STOP - EXIT
E4	Wheel rotation direction is reversed - Disconnect power and correct wiring
E5	Stop time too long - Verify power supply and motor connection - press STOP - EXIT
E6	Encoder is not connected or has failed - Disconnect power supply and repair
E9	Wheel coast speed is too slow
E11	User cancelled the operation
E20	Arm scale is out of range
E24	Lower hood to spin
E25	Loose hub nut. Tighten hub nut and respin
E26	CAL ERROR
Err Hod	Hood switch is not closed when machine cycle is started - Lower hood to spin - Verify hood switch
Err Hub	No load condition detected - Verify wheel mounted properly on the shaft - Check repeatability
Err Ad	No dimension input
Inverter Error	Inverter Fault-Please Wait

Error	Description
100, N01, CAL	Exceeded 5 degree range between placement of calibration weight from outside flange to inside flange.
100, N02, CAL	Calibration wheel is more than 1-ounce unbalance. Calibration is rejected.
100, N03, CAL	Calibration wheel is more than 0.25-ounce but less than 1-ounce unbalance. Calibration is stored, but with warning.

Inverter Error - An inverter error occurs when one of several fault conditions is detected by the inverter; such as, low line voltage, motor over temperature, motor overload or motor drive over temperature. The balancer will not respond to inputs until the fault condition is corrected. The balancer will clear this error as soon as possible and indicate that with the following message: Inverter Fault Cleared. Press Any Icon (key).

Overload Protection - The balancer's motor is overload protected per UL requirements. After 4 to 5 minutes the machine automatically resets itself; activating the fan motor. If this happens, notify your Certified Service Partner immediately.

Important: Allow the fan to cool the motor for at least 30 minutes before using the balancer so the overload protection is not tripped again.

Notice: No service is allowed on the A & D line laser, T2 or 12 o'clock laser by the customer.

Notice: This unit is to be serviced or repaired only by factory authorized technicians.

Notes

